

# Hallberg-Rassy 400

Design: Germán Frers

## STANDARD SPECIFICATION

### Main datas:

Designer	Germán Frers	
Hull length	12.30 m	40' 4"
Maximum length	13.06 m	42' 10"
Waterline at rest	11.74 m	38' 6"
Beam	4.18 m	13' 8 1/2"
Draft, empty load	1.92 m*	6' 4" *
Displacement, empty standard boat	11 t	24 250 lbs
Lead keel	3.65 t	8 050 lbs
Sail area with working jib	90.1 m <sup>2</sup>	970 ft <sup>2</sup>
Sail area, optionally optimized	96.6 m <sup>2</sup>	1 040 ft <sup>2</sup>
Engine, Volvo Penta	D2-60	
Cylinder volume	2.2 litres	
Power at crank shaft	44 kW / 60 HP	
Max torque	169Nm/2000 rpm	
Fresh water tanks, appx.	520 l	137 US gal.
Diesel tanks, appx.	400 l	106 US gal.
Mast over water, ex Windex	19.75 m	64' 10"

*\*Also available as a shallow draught version upon request*



 Hallberg-Rassy

# Hallberg-Rassy 400

## standard specification

### Hull and Deck

Laminate construction of hull: Isophtalic gelcoat, vinylester based barrier coat. Hand lay-up method, insulated with Divinycell PVC-foam against heat and cold except in the keel area which is solid laminate. Integrated rubbing strake with brass strip. Blue decorative band in gelcoat. Strong under floor reinforcements. Lead keel bolted on with many stainless steel bolts. The rudders are carefully mounted for sensitive rudder feel. Strong engine foundations of GRP for effective sound insulation. Deck and coachroof areas and also cockpit are of sandwich construction, solid in parts, laminated to the hull. Six hull portlights.

### Deck and deck fittings

Toerail, cockpit seats, cockpit floor and bathing platform in top quality teak laid in silicon rubber. Solid teak hand rails full length of superstructure. Strong stem fitting. Stowage beneath for fenders. Two strong cleats forward, aft and midships. Double stainless lifelines. Scuppers on each side which drain rain water overboard just above waterline to prevent staining the hull. Genoajib and mainsheet tracks with blocks. Genoajib block adjustable from the cockpit. Selftailing genoa winches, size 50 Evo Chrome. Hatches in foredeck, toilet compartment, stb side of that, two in the saloon and one in the aft cabin. 8 port holes, 6 of these are opening. Pulpit and pushpit have opening for easy access on board. There is a separate gas locker with stowage for two 6 kg PK6 gas cylinders. Bathing platform in transom.

### Cockpit

On starboard side there is a generously sized, dry stowage locker with storage slots for wash boards. Further smaller cockpit locker to port side. The cockpit floor is covered with a teak grating. Twin wheel steering with large pedestal heads. Instruments for engine in the stb steering pedestal within easy reach of helmsman. Strong tempered glass windscreen with handholds on the sides, opening centre section and sprayhood over front part of cockpit. The sprayhood can be rolled away neatly into a protective cover. On either side of sliding hatch there are useful teak covered work surfaces, ideal as chart tables, etc. Above the sliding hatch Raymarine instruments; one i50 Speed, one i50 Depth and i60 Wind. Chart tables and washboards in natural teak. Halyard winches size 40 Evo chrome and clutches on ps and stb coamings.

### Mast and rigging

Triple spreader rig by Seldén. Main boom with outhaul and two reefs. Under deck genoajib furling and reefing system Seldén Furlex TD. Seldén rod-kicker. Backstay tensioner, tackle, with generous purchase. Cleats for various uses. Generous dimensions of standing and running rigging avoid fatigue during unrestricted ocean sailing. Turnbuckles from Seldén, winches from Lewmar. Windex wind indicator on mast top.

### Sails

Mainsail and genoajib made from high quality dacron material in special Offshore quality by Elvstrøm Sails, Denmark. Two reefs in main, battens and coded sail bags.

### Accommodation details

As standard the boat has two saloon sofas, one aft cabin with double berth, and one heads with shower. Optional layouts are subject to additional cost. If optional layout is required, this must be ordered and specifically confirmed.

All interior woodwork in light khaya mahogany matt silk finish. Flushed locker doors with invisible hinges and ventilation as far as possible. Floor is varnished real wood with inlaid holly strips. Saloon ceiling has paneling with mahogany strips and ceilings in remainder of boat have light lining. High quality fabric covered cushions on all berths 12 cm / 5" thick sandwich foam resting on un-varnished, well ventilated boards to avoid condensation. Hand holds are in all the right positions. All portholes are fitted with curtains. Curtains also under the deck hatches in sleeping cabins.

### Saloon

The settee offers comfortable seating. On the port side a 2.10 m long L-sofa that has backrests with hinges so that the space behind can be utilized as storage. On starboard side 2.10 m long settee (with optional twin aft cabins 1.95 m). The backrest can be lifted to enable total width to be used for sleeping accommodation. Between the settees a strong table with foldable sides. Top opening bar in the table. Headroom in saloon approximately 1.94 m.

### Galley

Working surface in Corian with strong, all round mahogany fiddle rail. Carefully insulated cooling box with baskets and electric compressor for chilling. Extra deep, double sink. Two burner gas cooker with oven, well gimbaled with fiddle rails and locking device for oven door and also for the cooker when in use in the marina. Safety switch on gas pipe. Crockery locker and cutlery drawer. Cutting board. Room for saucepans and other kitchen utensils. There is a special place for the waste bin.

### Heads Compartment

Bulkheads in white laminate. Teak grating. Wash basin and countertop in Corian. There is a large mirror fitted. Separate shower with watertight shower stall and acrylic glass doors. Shower water drained by pump directly overboard without going into bilges. Hand switch for shower pump for utmost safety. Strong, reliable pump action toilet. Holding tank, emptied by gravity or by deck pump out. Cupboard above and below wash-basin. Ventilation through an opening porthole and a frosted deck hatch.

### Forward Cabin

The door to the forward cabin has been arranged in such a way to allow free movement for dressing and undressing. Two 2.11 m long berths with ample stowage above and below and in addition a number

of lockers. An automatic deck vent, a deck hatch and an opening porthole.

### **Work Table**

A comfortable work table seat. Fold-out electric panel to the right of the navigator. Drawers and stowage slots.

### **Aft Cabin**

The aft cabin has a hanging locker and a comfortable double berth, 2.04 m long, 1.47 m wide. Stowage room below and above the berths. As an option at additional cost twin aft cabins can be ordered.

### **Engine and Engine Room**

Engine Volvo Penta D2-60, 44 kW/60 HP 4 cylinder 2.2 Litres cylinder volume. Mounted with rubber feet on strong foundations to avoid vibration and noise. 3 bladed fixed propeller. Water-cooled rubber exhaust pipe. Fresh-water cooled engine. The hot freshwater circuit is led into a 40 L / 11 US gallon well insulated hot water tank. Due to the good insulation water remains hot for many hours after the engine has been run. The engine is served by a separate 12 V battery. There is a large filter for cooling water. Automatic fire extinguisher in engine room. The bilge pump has been installed in a position where it can be cleaned even in extremely bad weather conditions. There is space for a diesel generator.

### **Diesel**

400 litres in two tanks with fuel gauges. The tanks are filled through two deck inlets. Between tank and engine there is a further large water trap and coarse filter in addition to the one on the engine.

### **Fresh Water**

Fresh water capacity is 520 litres in three tanks. The hot water calorifier has 40 litres. The upper tanks are piped to lower tank and controlled by valves. There is a water gauge for each tank. The hot water calorifier is heated by a 230 V immersion heater as well as the engine's cooling water. As soon as a water tap is turned on the water which is under pressure in the pipes starts to flow. As soon as the pressure reduces the electric pump begins to work and will continue until the pressure is built up again after closing tap. Filling of water tanks is through deck inlet. Carbon fresh water filter. There are two bilge pumps; one manual and one high capacity submersible electric emergency bilge pump.

### **Electricity**

Two separate DC circuits, one with 12 Volt and 95 Ah battery for engine start and one 12 Volt 240 Ah deep-cycle for general use on board, the latter being covered by two batteries. Charging of batteries is by 115 A alternator from engine. Lighting throughout the boat is located in all the important positions. There are attractive adjustable reading lights above the berths. Electric 12 v sockets at inner chart table and in the cockpit. Electric panel with circuit breakers at inner chart table. There is a fresh water and diesel meter. LED navigation lights and a steaming light. A wiring diagram is supplied with each boat.

### **Refrigeration**

An Isotherm system with Danfoss compressor unit for refrigeration is fitted for the 92 liters cooling box, economical to run.

### **Ventilation**

7 deck hatches, 6 opening port holes, companionway washboards, 3 automatic vents. Separate electric engine room ventilation.

### **Steering**

Twin wheel steering. Cardan linked rod steering which is progressive and combines safety and fine feel in the best possible way. Illuminated compass, single lever engine control and leather covered steering wheel.

### **Safety and General**

All outside skin fittings are speedily and securely sealed by using ball-valves with Delrin-sealer. Double hose clips are used under water. For the toilet special non-diffusing hoses are used. All electric cables are, where possible, laid in special tubes and where this is not possible, cables are safely loomed away from the hull. There are large limber holes so that any water can easily drain to the bilge, except directly under the engine, which is a separate oil bilge. The main bilge is accessible by a removable floor panel. Inspection hatches for easy access to stop cocks and speed transducer. Three fire extinguishers, one fitted to the saloon table, one in the aft cabin and one in the cockpit locker. Fixed automatic fire extinguisher in engine room. Fire and smoke detector in the saloon area.

### **Type of Finish**

The interior is treated with a top quality silk finish varnish. The underwater hull has two applications of epoxy primer and two coats of antifouling.

### **Certification**

The boat is CE certified by DNV-GL (Det Norske Veritas-Germanischer Lloyd) and delivered with a CE certificate and a CE plaque for category A - unlimited ocean voyages.

### **Loose Equipment**

- Flagstaff
- Boat hook
- Four fenders
- Four mooring lines
- Emergency steering
- Main sail cover (not supplied if furling mast is ordered)
- One winch handle

*Modifications reserved. Chosen extra equipment may affect this standard specification. Drawings and illustrations are for orientation only. Measurements are not to be taken from these. Drawings and illustrations may show options at additional cost.*

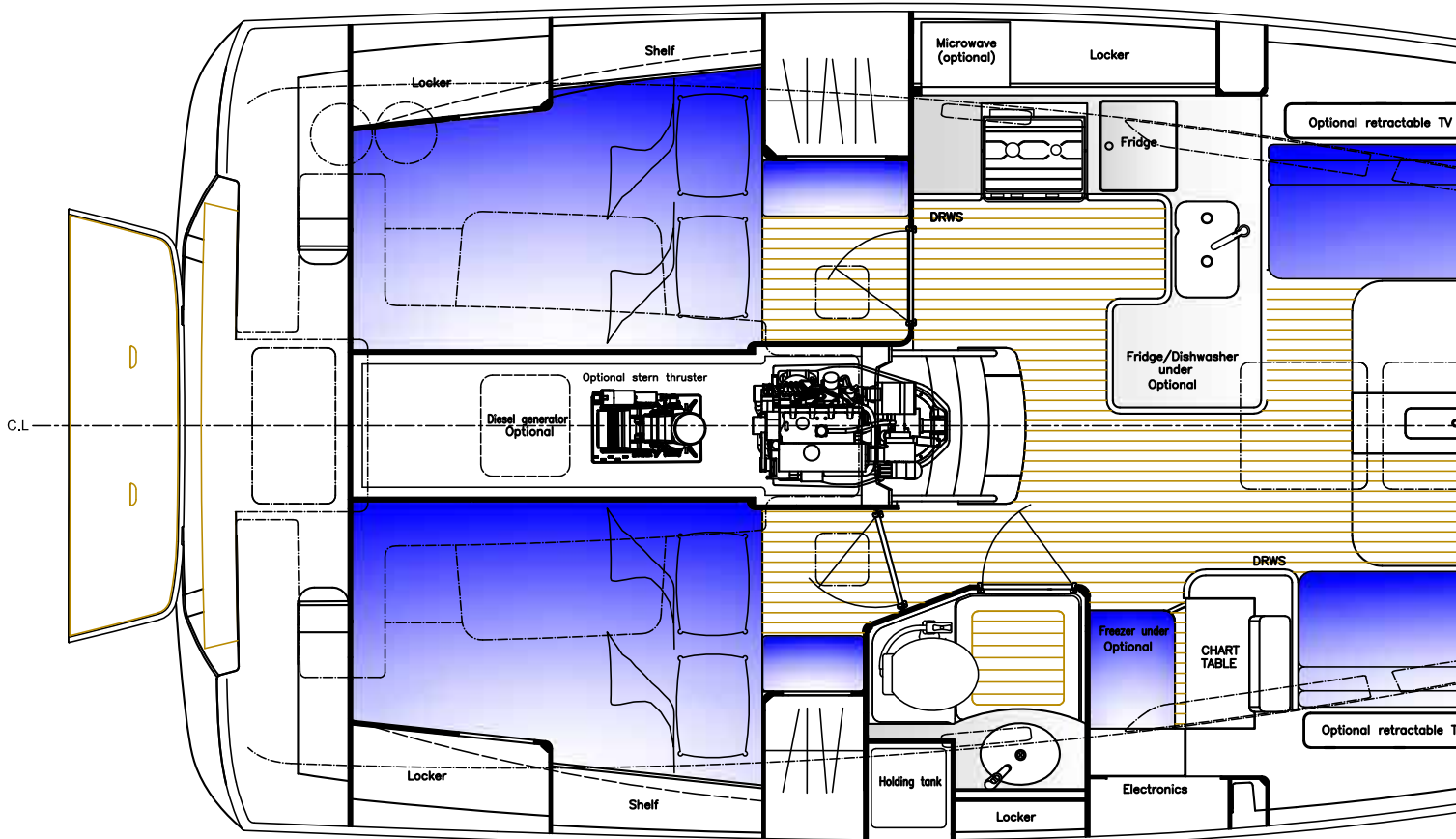
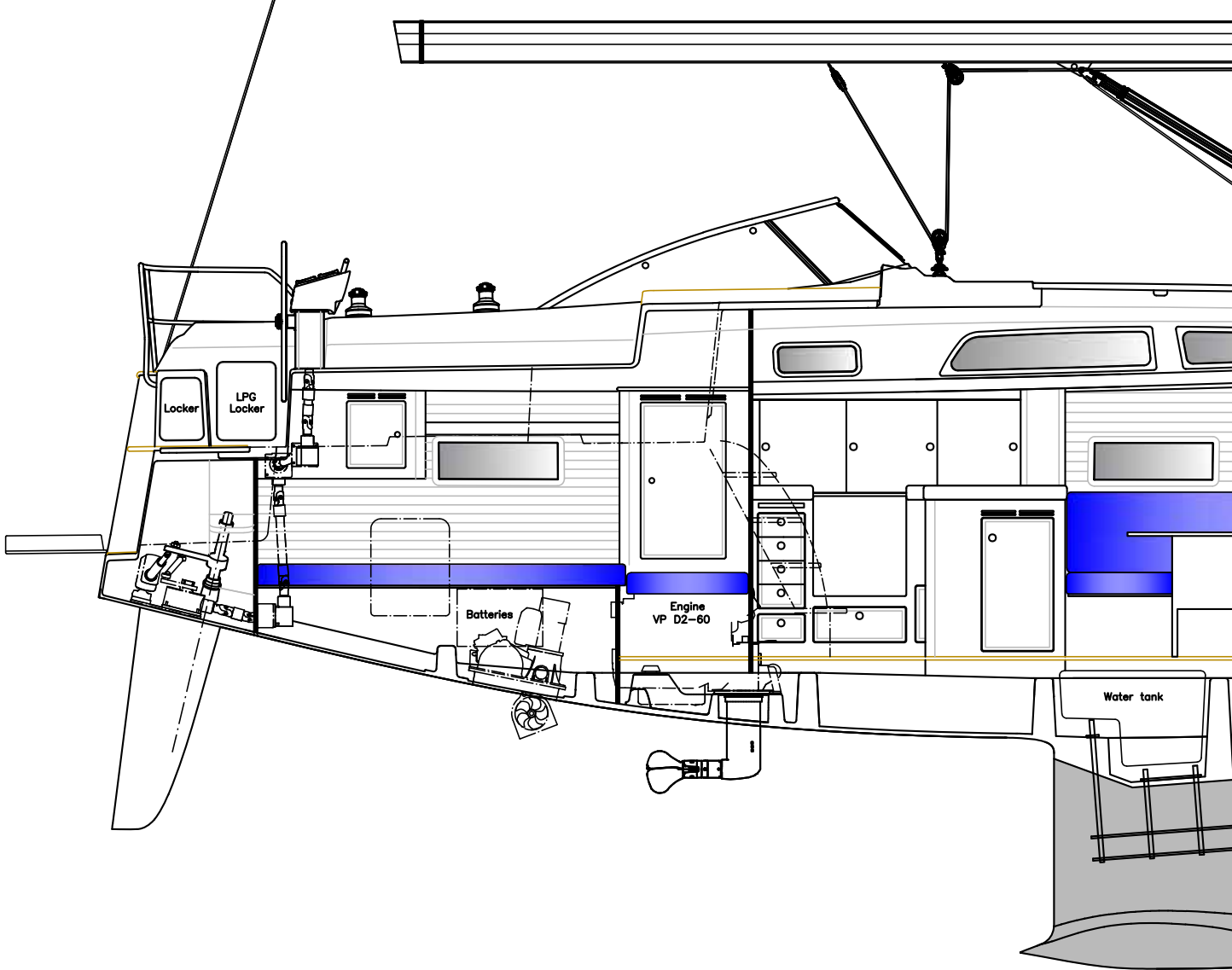

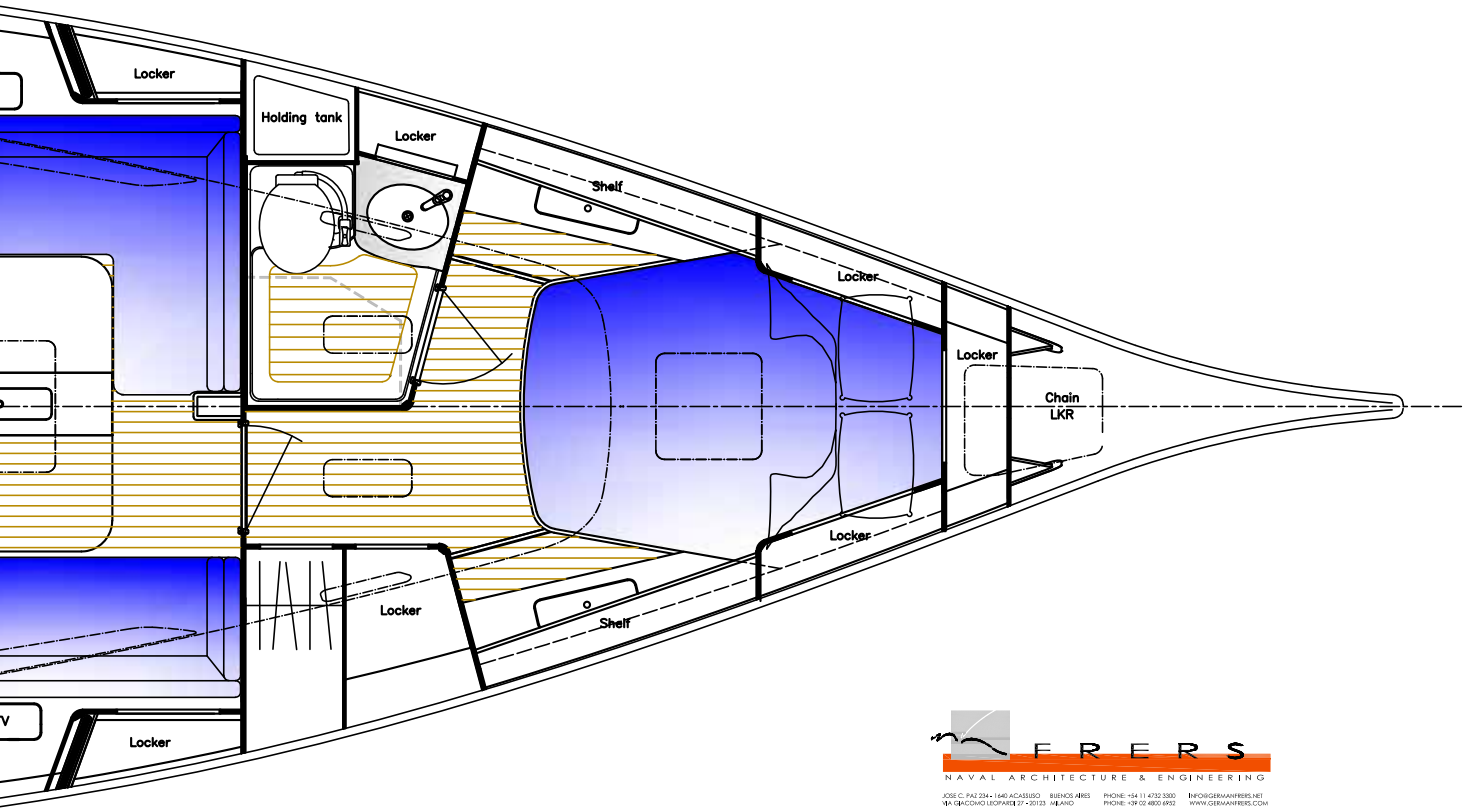
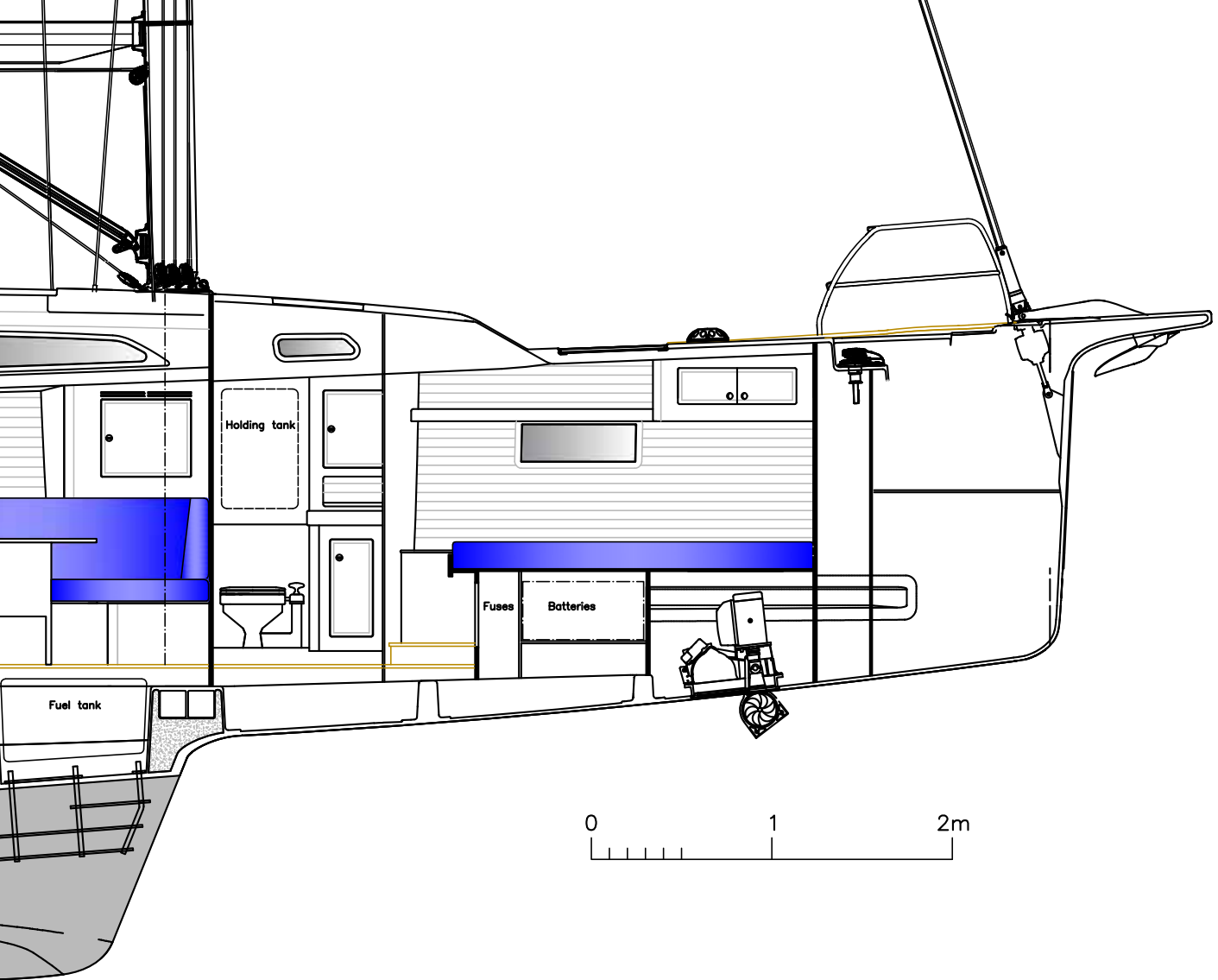

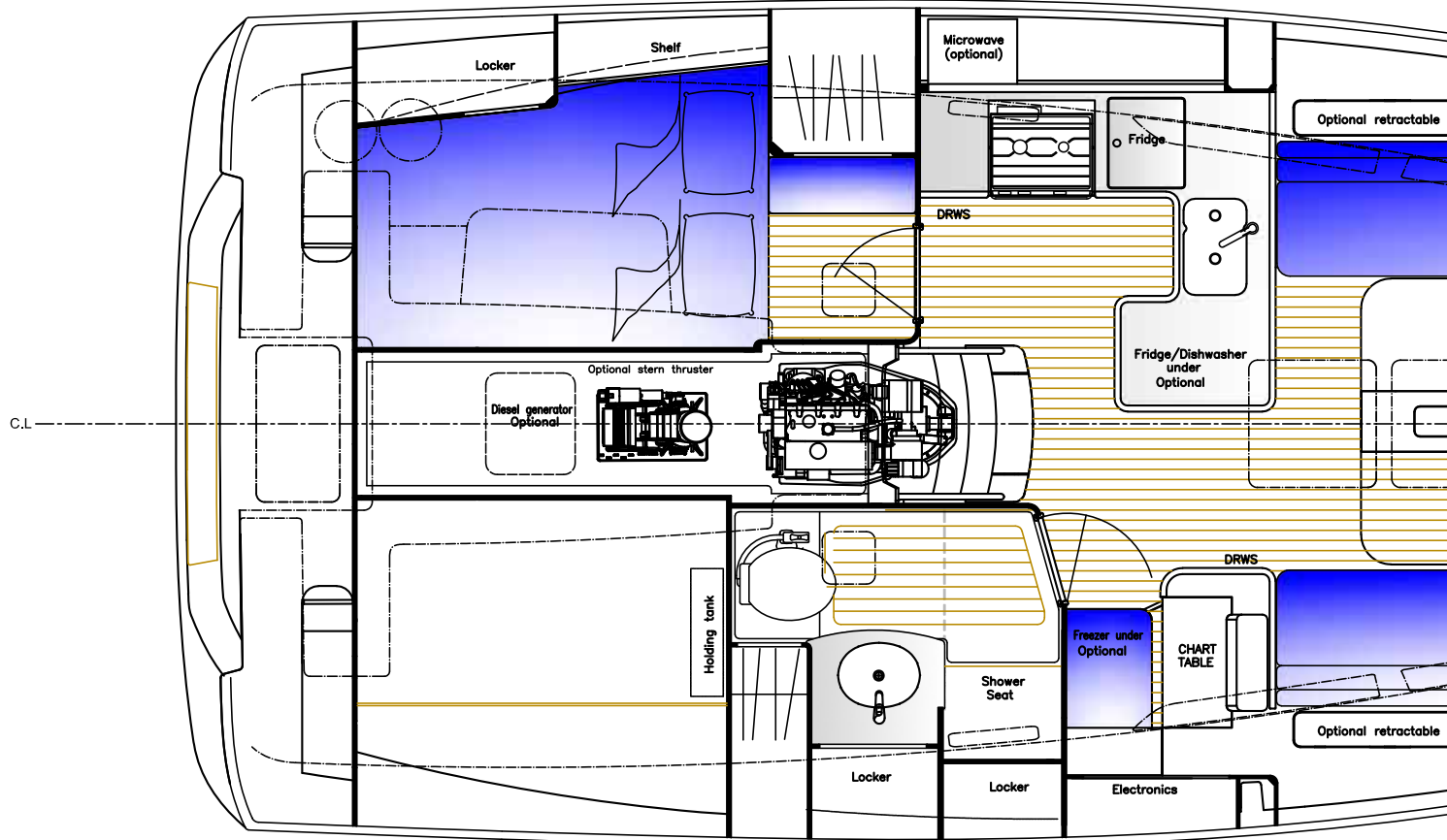
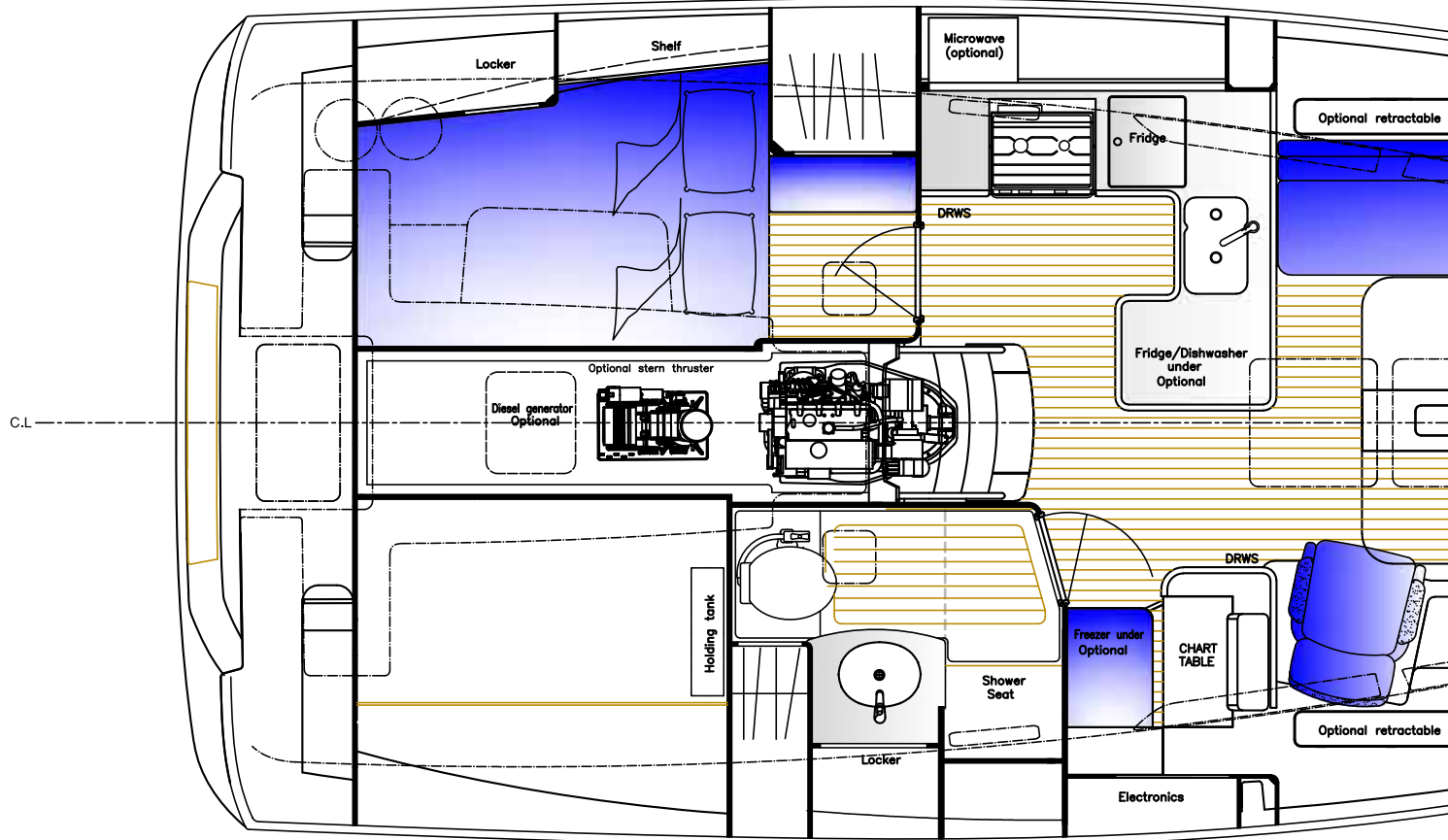

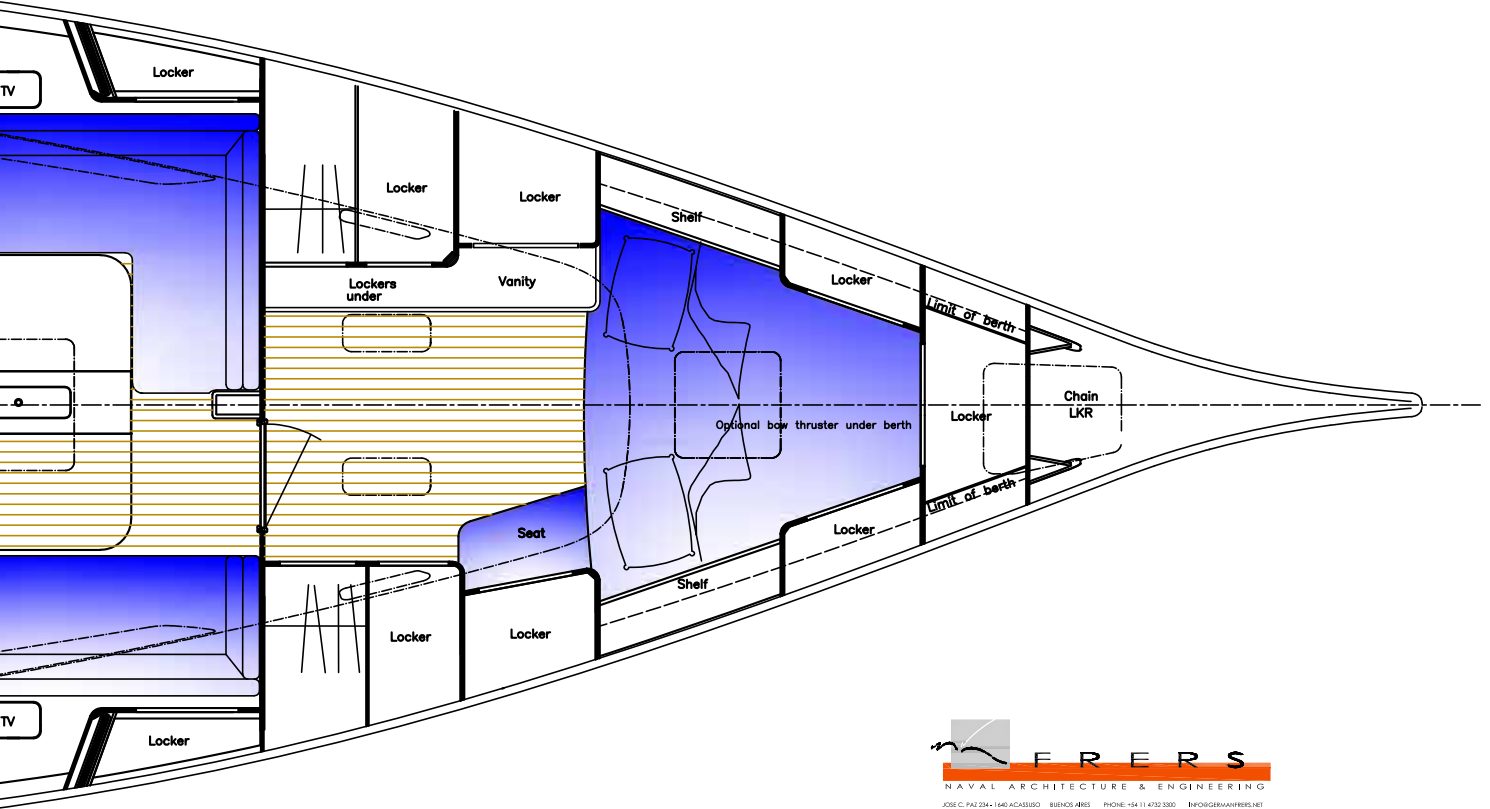
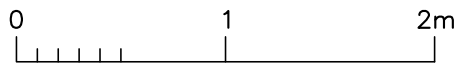
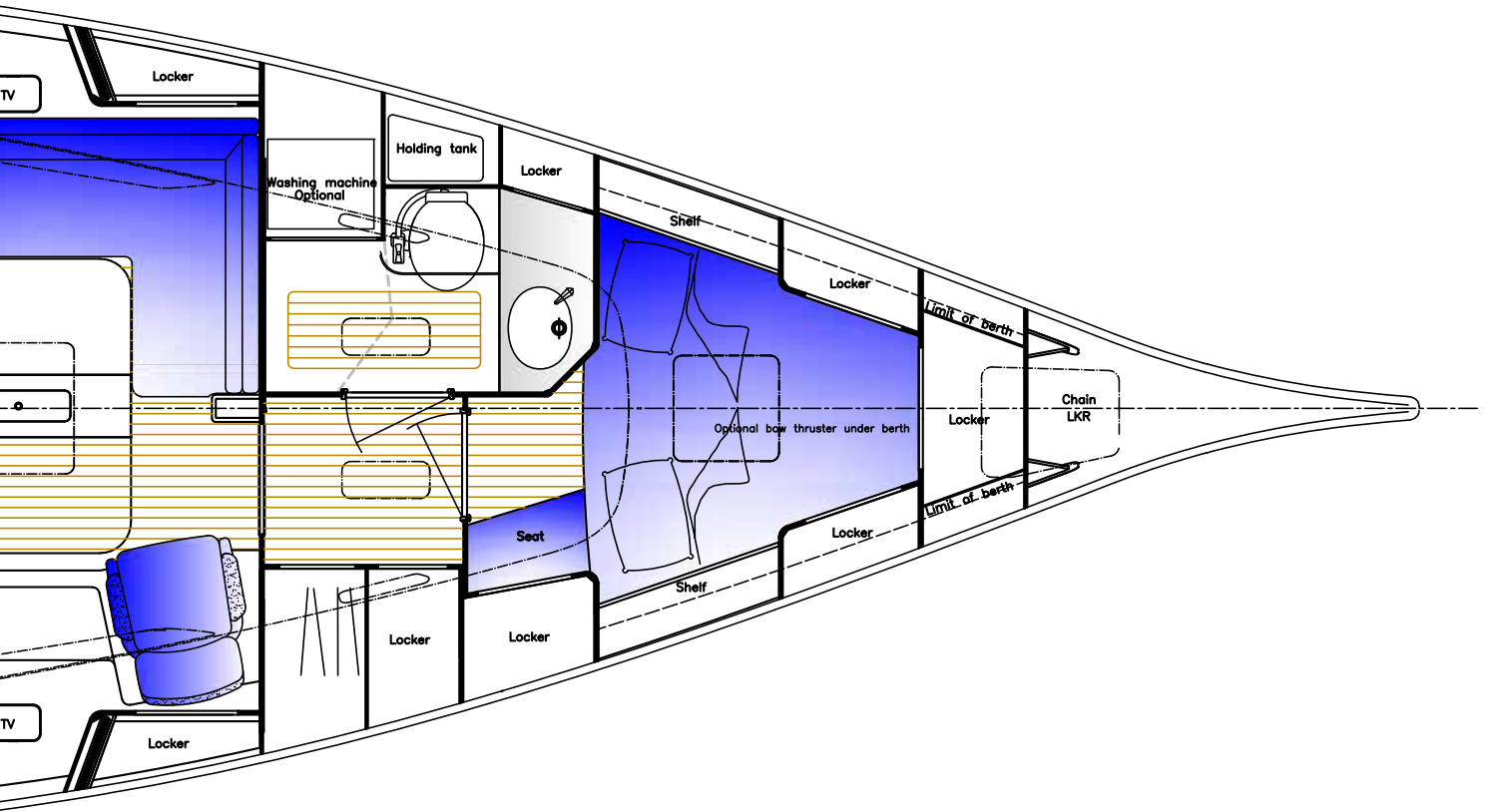



# Hallberg-Rassy

HALLBERG-RASSY VARVS AB, HALLBERG-RASSYVÄGEN 1, SE-474 31 ELLÖS, SWEDEN. TEL +46-(0)304-54 800  
[facebook.com/hallberg-rassy](https://facebook.com/hallberg-rassy) [instagram.com/hallberg-rassy](https://instagram.com/hallberg-rassy)  
[www.hallberg-rassy.com](http://www.hallberg-rassy.com)

**SPARE PARTS:** HALLBERG-RASSY PARTS AB, HALLBERG-RASSYVÄGEN 2, SE-474 31 ELLÖS, SWEDEN. TEL +46-(0) 304 549 90. [info@hr-parts.com](mailto:info@hr-parts.com)  
[shop.hallberg-rassy.com](http://shop.hallberg-rassy.com)

**AUSTRALIA AND NEW ZEALAND:** DBY BOAT SALES, PRINCES ST MARINA, 16 PRINCES ST, NEWPORT, SYDNEY NSW 2106, AUSTRALIA.  
 TEL: +61 2 9999 3311 [sales@dbyboatsales.com.au](mailto:sales@dbyboatsales.com.au)

**BULGARIA:** FINNINVEST LTD., BOGORIDY ST No 59, BG-8000 BOURGAS.  
 TEL +359 (0)56 845 107 [fininv@bs.spnet.net](mailto:fininv@bs.spnet.net)

**CROATIA, SERBIA, SLOVENIA, BOSNIA AND HERCEGOVINA, MACEDONIA AND MONTENEGRO:** MORE OCEAN D.O.O., SMICIKLASOVA 19, HR-10 000 ZAGREB, CROATIA [marko@moreocean.hr](mailto:marko@moreocean.hr) TEL +385 1 5509501

**DENMARK:** DIRECTLY FROM THE YARD IN SWEDEN.

**FINLAND:** OY HELLMAN YACHTS AB, TAMMISTONTIE 256, FIN-20900 TURKU TEL +358 (0)2 2581 600 [lassi.hellman@helmarin.fi](mailto:lassi.hellman@helmarin.fi)

**GERMANY:** HALLBERG-RASSY DEUTSCHLAND GMBH, AN DER WIEK 7-15, DE-23730 NEUSTADT. [info@hallberg-rassy.de](mailto:info@hallberg-rassy.de) TEL 04561-55 86 48.

**HOLLAND:** NOVA YACHTING INT. BV, JACHTHAVEN BRUINISSE, JACHTHAVENWEG 72, NL-4311 NC BRUINISSE. TEL +31-111-48 18 10. [info@nova-yachting.nl](mailto:info@nova-yachting.nl)

**ITALY:** MARINE LIONS YACHTING SRL, VIA SALENTO 12, IT-00162 ROMA.  
 TEL 06-44 23 75 37. [info@hallberg-rassy.it](mailto:info@hallberg-rassy.it)

**JAPAN:** KAIWO Co., LTD, 4-3 SHIRAHO, KANAZAWA-KU, YOKOHAMA, 236-0007  
 TEL: 81-45-773-0685 [info@kaiwo.com](mailto:info@kaiwo.com)

**NORWAY:** DIRECTLY FROM THE YARD IN SWEDEN.

**RUSSIA:** JONACOR MARINE, PESOCHNAYA NAB.18, RU-197022 ST. PETERSBURG  
 TEL: +7 (812) 702 47 70 [dmitry.samoylov@jonacor-marine.ru](mailto:dmitry.samoylov@jonacor-marine.ru)

**SOUTH KOREA:** GIN-A Co., LTD., BUILDING AND SUITE NUMBER: DONGBU ROOT BLDG. SUITE 708, DISTRICT AND STREET: BUNDANG-GU HWANGSEUL-RO 200-GIL 36, CITY: SEONGNAM, PROVINCE: GYEONGGI-DO, POSTAL CODE: 13595  
 TEL: +82-31-711-9681 [yacht@gin-a.kr](mailto:yacht@gin-a.kr)

**SPAIN:** OLMARINE, PORT GINESTA - LOCAL 720, ES-08860 LES BOTIGUES DE SITGES (BARCELONA) TEL +34 620275011 [info@olmarine.es](mailto:info@olmarine.es)

**SWITZERLAND:** BOOTSWERFT ROLF MÜLLER AG, BOTTIGHOFEN, CH-8574 LENGWIL  
 TEL 071-688 41 41. [info@bootswert-mueller.swiss](mailto:info@bootswert-mueller.swiss)

**TURKEY:** GALIP KAYNAR, PRIENE TURIZM VE YATCILIK LTD. STI., TESVIKIYE CAD No 45/1 NISANTASI, TR-34367 SISLI, ISTANBUL. TEL +90 212 2412241  
[galipkaynar@galipkaynar.com](mailto:galipkaynar@galipkaynar.com)

**UK:** TRANSWORLD YACHTS SAILING LTD., HAMBLE POINT MARINA, SCHOOL LANE, HAMBLE, SOUTHAMPTON SO31 4JD  
 TEL 023-80 45 40 00 [enq@transworld-yachts.co.uk](mailto:enq@transworld-yachts.co.uk)

**USA, MD:** FREE STATE YACHTS INC., HERRINGTON HARBOUR MARINA NORTH, P O Box 220, DEALE, MARYLAND 20751, TEL: 410-867-9022, 800-871-1333.  
[sales@freestateyachts.com](mailto:sales@freestateyachts.com)

**USA, WA:** SWIFTSURE YACHTS, 2500 WESTLAKE AVE. N., SUITE A, SEATTLE WA 98109 TEL 206 378 1110 [info@swiftsureyachts.com](mailto:info@swiftsureyachts.com)